

5N1, capacity 596 kg

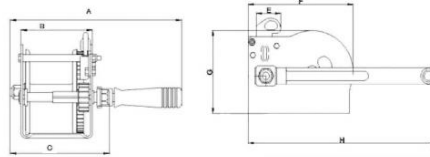

Pulling winch 596 kg.

Use:

- Pulling/Hauling operations only (slope of 0%)
- Occasional use or leisure
- Tensioning of cables or nets
- Pulling of boats...

Technical properties

- Compact.
- Faible encombrement.
- Robust.
- Holding and disengaging ratchet.
- Easy to install (3 attachment points depending on models).
- To use with steel ropes.
- Zinc protection.

Technical characteristics of 5N1, capacity 596 kg

Wire rope cap. top layer m	10
Pulling capacity (slope of 0%) kg	596
Wire rope Ø mm	6
Weight (without wire rope) kg	3

Dimensions

A mm	240
B mm	99
C mm	140
E mm	38
F mm	161
N mm	-
G mm	127
H mm	240

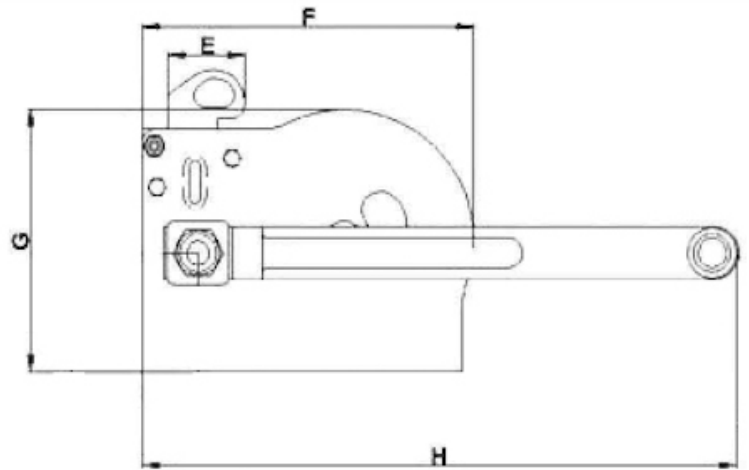
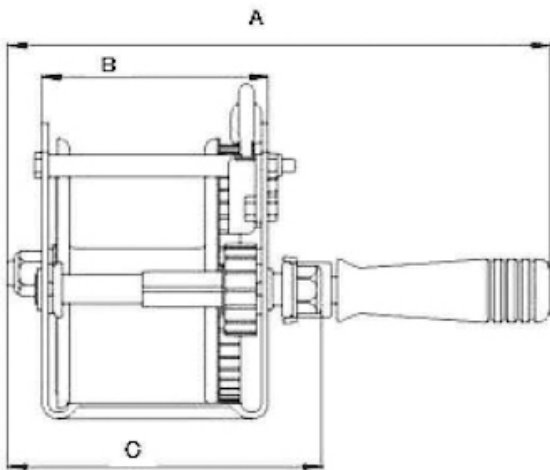

Technical characteristics of the other models of the range

References	3N1	5N1	7N1	9N1	16N2F
Wire rope cap. top layer m	13	10	14	16	10
Pulling capacity (slope of 0%) kg	470	596	723	894	1556
Wire rope Ø mm	4	6	7	7	8
Weight (without wire rope) kg	2	3	4.6	6	7.8

References	25N3F
Wire rope cap. top layer m	13
Pulling capacity (slope of 0%) kg	2741
Wire rope Ø mm	9
Weight (without wire rope) kg	13.1



HUCHEZ's advice

Compact, easy to install and to use.



HUCHEZ
9, Grande Rue
60420 FERRIERES – France
☎ +33 (0) 3 44 51 11 33
Site internet : www.huchez.com
E-mail : contact@huchez.fr



SERVICE
CLIENTS

Pour en savoir plus, n'hésitez pas à nous contacter !
To know more, please contact us!